

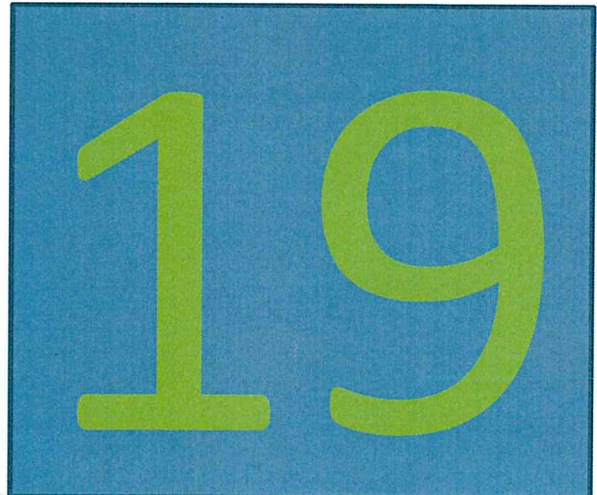

ASSORTIMENTI PER ESPOSITORI

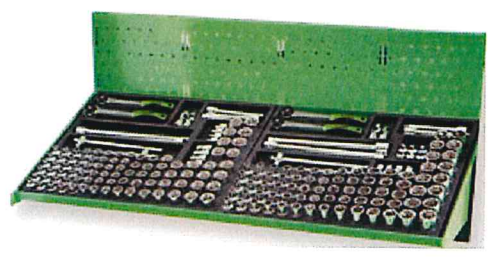

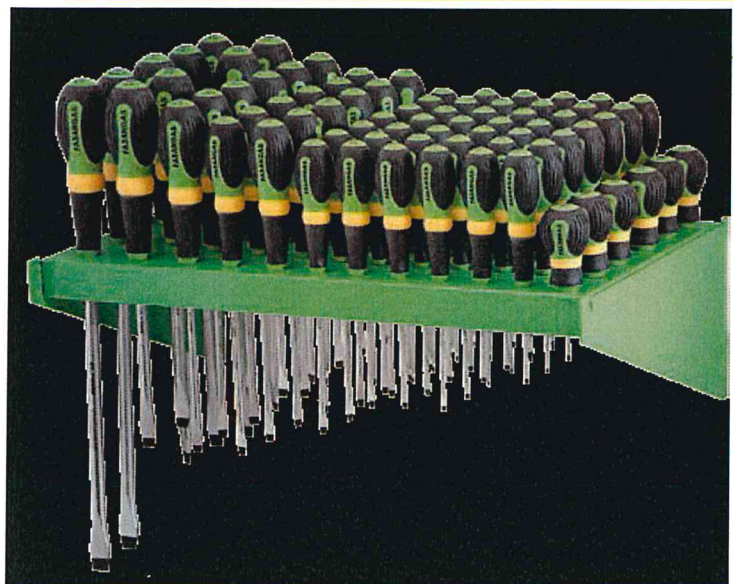

FG ES/8

FG ES/7

FG ES/6

ESPOSITORI

FG ES/100
Esposizione 8 espositori completi
di 2.018 utensili + modulo angolare vuoto

Lunghezza lineare totale: 7.70mt.

Listino: €

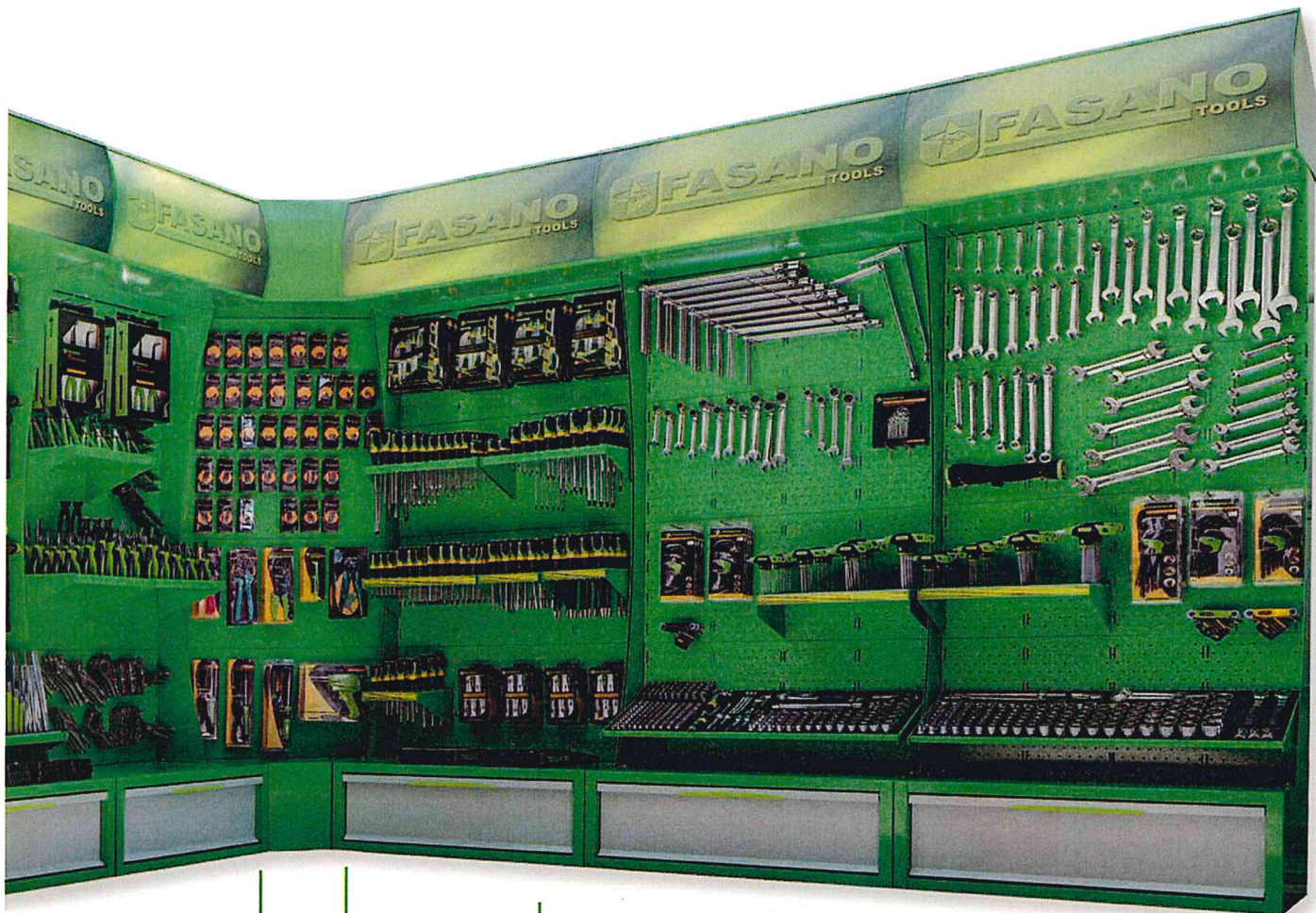

FG ES/5

FG ES/4

FG ES/V6

FG ES/3

FG ES/2

FG ES/1

ESPOSITORI PORTA-UTENSILI

493

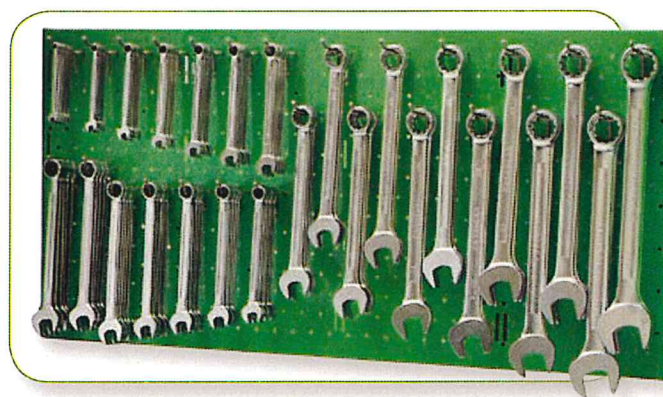

**FG 900/A1**

Assortimento chiavi combinate

CODICE	mm	C.AD
FG 600/B...	6, 7, 8, 9, 10, 11, 12, 13, 14, 15, 16, 17, 18, 19	10x
FG 600/B...	20, 21, 22, 23, 24, 25, 26, 27, 28, 29, 30, 32	03x

Listino: €

FG 900/A1B
 Assortimento chiavi combinate e a cricco

CODICE	mm	C.AD
FG 600/B...	6, 7, 8, 9, 10, 11, 12, 13, 14, 15, 16, 17, 18, 19	10x
FG 605/S5	8 - 19mm	06x

Listino: €

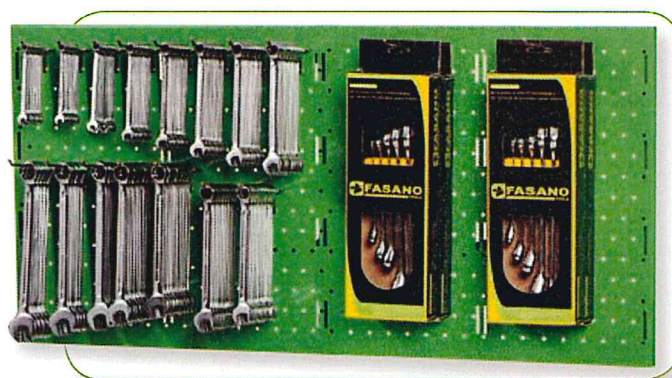
**FG 900/A2**

Assortimento chiavi combinate

CODICE	mm	C.AD
FG 615/B...	6x7, 8x9, 10x11, 12x13, 14x15, 16x17, 18x19, 21x23	05x
FG 615/SP9	6x7 - 21x23	02x
FG 602/B...	6x7, 8x9, 10x11, 12x13, 14x15, 16x17, 18x19	05x
FG 602/B...	20x22, 21x23, 24x26, 25x28, 27x29, 30x32	03x

Listino: €

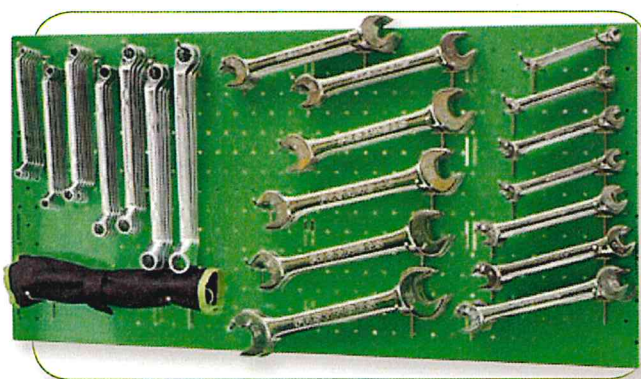
FG 900/A4
 Assortimento chiavi a T snodate

CODICE	mm	C.AD
FG 618/B...	8, 10, 11, 12, 13, 14, 15, 16, 17, 18, 19	05x

Listino: €

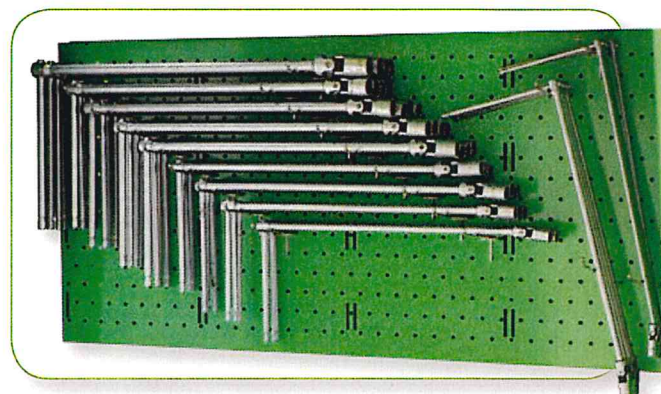

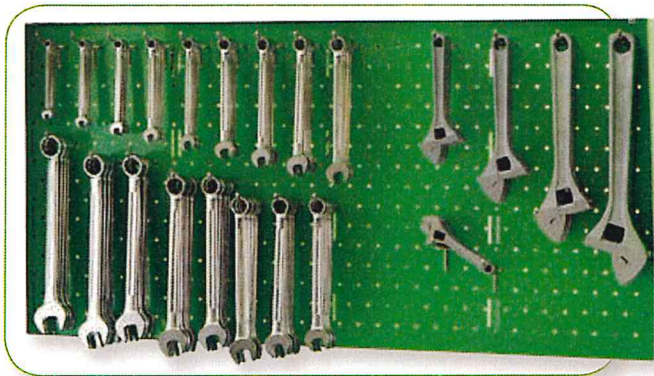

FG 900/A5
Assortimento chiavi combinate
e chiavi a rullino

CODICE	mm	C.AD
FG 600/B...	6, 7, 8, 9, 10, 11, 12, 13, 14, 15, 16, 17, 18, 19, 20, 21, 22	10x
FG 35/B...	1, 2	05x
FG 35/B...	3, 4, 5	03x

Listino: €

FG 900/A10
Assortimento chiavi maschio TX

CODICE	mm	C.AD
FG 143/TX...	15	05x
FG 143/TX...	10, 20, 25, 40, 45, 50	04x
FG 143/TX...	27, 30	02x
FG 137		04x
FG 138		04x
FG 138C/FS		02x

Listino: €



FG 900/A11
Assortimento chiavi maschio esagonali

CODICE	mm	C.AD
FG 142/...	2.5	05x
FG 142/...	2, 3, 4, 5, 6, 8, 10	04x
FG 139		04x
FG 139C/FS		02x
FG 139/L		04x
FG 139/IN		04x
FG 139FS/IN		02x

Listino: €



FG 900/A12
Assortimento chiavi maschio esagonali

CODICE	mm	C.AD
FG 143/TX...	15	05x
FG 143/TX...	10, 20, 25, 40, 45, 50	04x
FG 143/TX...	27, 30	02x
FG 142/...	2.5	05x
FG 142/...	2, 3, 4, 5, 6, 8, 10	04x

Listino: €





FG 900/A9B

Assortimento set chiavi maschio e inserti da 1/4"

CODICE	C.AD
FG 139	05x
FG 139/LM	05x
FG 139/B	05x
FG 138	05x
FG 138/M	03x
FG 85/S11	05x
FG 85TX/S11	04x

Listino: €



FG 900/A13 Assortimento giraviti ESTRO a taglio e croce PH

COD	mm	C.AD	COD	mm	C.AD
FG 22/...	12x250	02x	FG 22/...	PH4x200	05x
FG 22/...	4x30,6.5x30,10x200	03x	FG 22/...	PH3x150	05x
FG 22/...	8x150	05x	FG 22/...	PH2x100H	05x
FG 22/...	5.5x100,5.5x150,6.5x150	06x	FG 22/...	PH1x30,2x30,1x80,,1x200,2x100,2x150	06x
FG 22/...	2.5x60,3x75,3x100,3.5x100,4x100,4x125	07x			

Listino: €

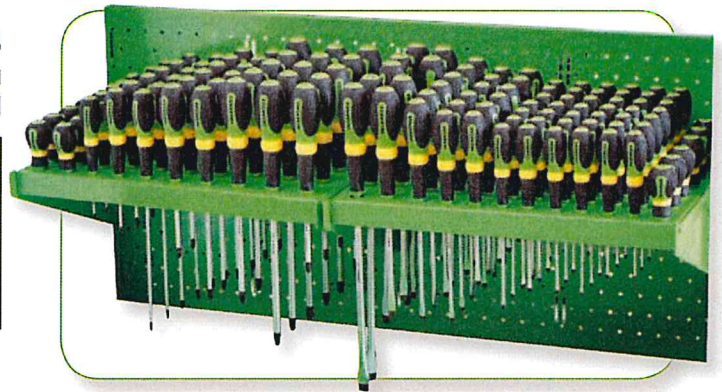

FG 900/A14

Assortimento giraviti ESTRO con impronta TX, TX con foro e a bussola (flex e rigidi)

CODICE	mm	CAD	CODICE	mm	C.AD
FG 22/FL...	10x125	02x	FG 22/...	TX6, TX7, TX27, TX30, RTX10, RTX15, RTX20, RTX25, RTX27	03x
FG 22/FL...	8x125	03x	FG 22/...	RTX9	03x
FG 22/FL...	5x125,6x125,7x125	05x	FG 22/...	TX10, TX15, TX20, TX25,	06x
FG 22/FX...	10x125	02x	FG 22/...	TX8, TX9	07x
FG 22/FX...	8x125	03x			
FG 22/FX...	5x125,6x125,7x125	05x			

Listino: €

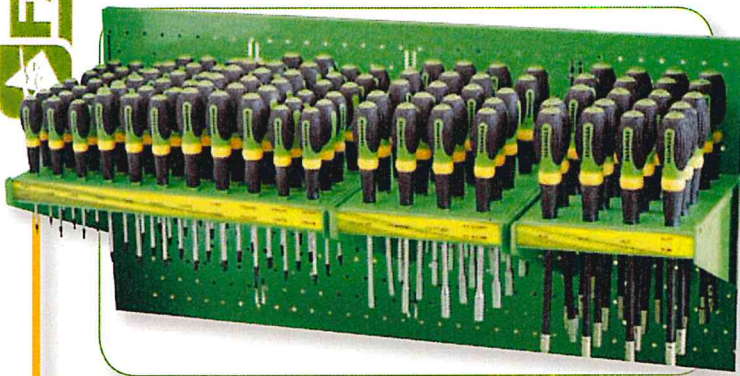

FG 900/A15 Assortimento giraviti ESTRO normali e isolati

CODE	mm	C.AD	CODE	mm	C.AD
FG 22/...	8x150	02x	FG 22E/...	6.5x150, 8x175 PH1x80, PH2x100, PH3x150 PZ1x80, PZ2x100, PX3x150	03X
FG 22/...	4x30, 4x125, 6.5x30, 5.5x100, 5.5x150, 10x200 PH1x30, PH2x30, PH1x80, PH2x100	03x	FG 22E/...	PH0x60 PZ0x60	04X
FG 22/...	4x100	04x	FG 22E/...	2.5x75, 3x100, 4x100, 5.5x125	07x
FG 22/...	PH3x150	05x			
FG 22/...	6.5x150	06x			
FG 22/...	3x75, 3.5x100 PH0x60	07x			

Listino: €

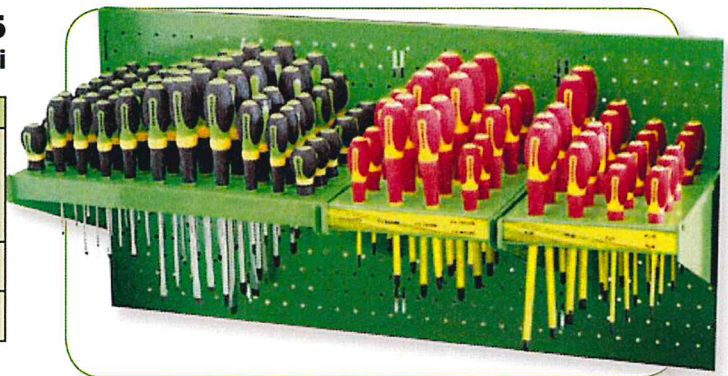

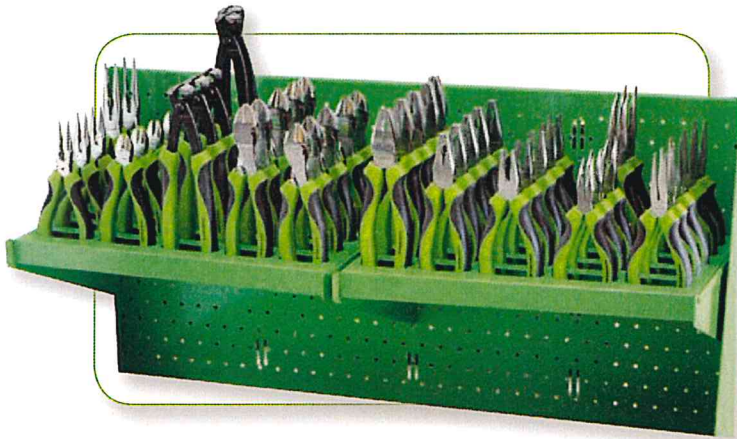

FG 900/A20 Assortimento pinze assortite

CODICE	mm	Q.TÀ
FG 59SR/...	160, 180, 200	05x
FG 60SR/...	160	03x
FG 60SR/...	200	02x
FG 62SR/...	160	05x

CODICE	mm	Q.TÀ
FG 61SR/...	160	03x
FG 61SR/...	200	02x
FG 63SR/...	160	05x
FG 63SR/H...	180, 200	05x
FG 64SR/...	220	03x
FG 64SR/...	280	02x

Listino: €

FG 900/A21 Assortimento pinze assortite

CODICE	mm	Q.TÀ
FG 59SR/...	180	02x
FG 59SR/...	200	03x
FG 61SR/...	160	02x
FG 60SR/...	160	03x
FG 58B/...	180	02x
FG 58B/...	240	05x
FG 58B/...	300	03x

CODICE	mm	Q.TÀ
FG 51/, FG 52/, FG 53/, FG 54/	140	02x
FG 51/, FG 52/, FG 53/, FG 54/	180	03x
FG 51/, FG 52/, FG 53/, FG 54/	230	01x

Listino: €

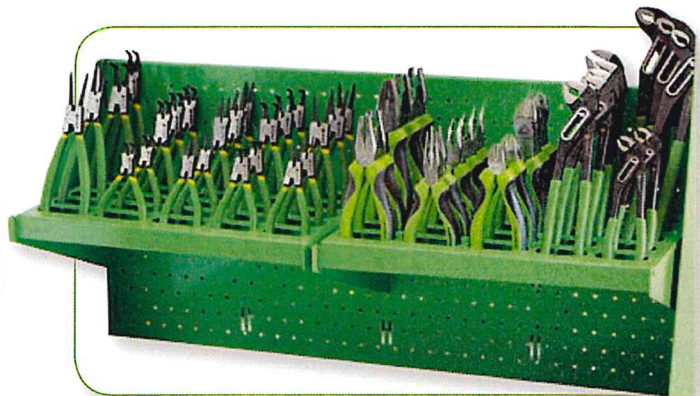

FG 900/A23 Assortimento pinze e giraviti ESTRO assortiti

CODE	mm	Q.TÀ
FG 22/...	8x150	02x
FG 22/...	4x30, 4x125, 6.5x30, 5.5x100, 5.5x150, 10x200 PH1x30, PH2x30, PH1x80, PH2x100	03x
FG 22/...	4x100	04x
FG 22/...	PH3x150	05x
FG 22/...	6.5x150	06x
FG 22/...	3x75, 3.5x100 PH0x60	07x

CODE	mm	Q.TÀ
FG 59SR/...	160, 180	02x
FG 59SR/...	200	01x
FG 60SR/...	160	03x
FG 61SR/...	160	05x
FG 62SR/...	160	02x
FG 63SR/...	160	05x
FG 63SR/H	180	02x
FG 63SR/H	200	03x

Listino: €

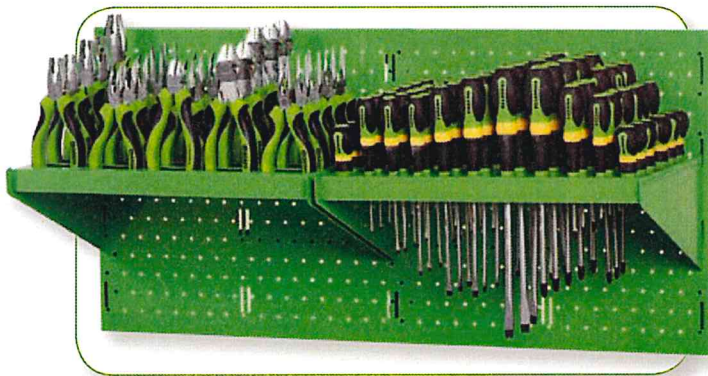

FG 900/A30 Assortimento 279 chiavi a bussola + accessori

CODICE	mm	Q.TÀ
FG 62A/E...	4, 5, 6, 7, 8, 9, 10, 11, 12	10x
FG 62A/E...	13	09x
FG 62A/E...	14	08x
FG 62A/E/L...	4, 5, 6, 7, 8, 9, 10, 11, 12, 13, 14	05x
FG 62A/AD1		05x
FG 62A/...	PR50, PRF150, SN14, ES14	03x
FG 62A/...	PR100	02x
FG 62A/...	GR14B, GR14C	01x
FG 62A/CR14		04x

CODICE	mm	Q.TÀ
FG 62A/B...	8, 9, 10, 11, 12, 13, 14, 15, 16, 17, 18, 19	05x
FG 62A/B...	21, 22	08x
FG 62A/...	AD1, AD2	03x
FG 62A/B/...	PA125, PA250, SN38, ES38	02x
FG 62A/CR38		02x
FG 62A/B/...	PR100	02x
FG 62A/B/...	GR14B, GR14C	01x
FG 62A/B/...		

Listino: €



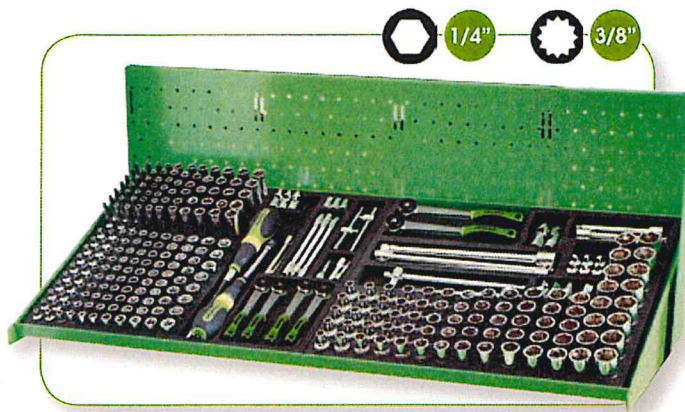

1/4" 3/8"

FG 900/A32

Assortimento 290 chiavi a bussola + accessori

CODICE	mm	Q.TÀ
FG 624/E...	4,5,6,7,8,9,10,11,12	10x
FG 624/E...	13	09x
FG 624/E...	14	08x
FG 624E/L...	4,5,6,7,8,9,10,11,12,13,14	05x
FG 624/AD1		05x
FG 624/...	PR50, PRF150, SN14, ES14	03x
FG 624/...	PR100	02x
FG 624/...	GR14B, GR14C	01x
FG 624/CR14		04x

CODICE	mm	Q.TÀ
FG 624/C...	6,7,8,9,10,11,12,13	06x
FG 624/C...	14,15,16	05x
FG 624/C...	17,18,19,20,21,22	04x
FG 624B/...	PA125, PA250, SN38, ES38	02x
FG 624/CR38		02x
FG 624/...	AD2, AD3	03x

Listino: €

FG 900/A33

Assortimento 192 chiavi a bussola + accessori

CODICE	mm	Q.TÀ
FG 624/B...	8,9,10,11,12,13,14,15,16,17,18,19	05x
FG 624/B...	21,22	05x
FG 624/...	AD1, AD2	03x
FG 624B/...	PA125, PA250, SN38, ES38	02x
FG 624/CR38		02x

CODICE	mm	Q.TÀ
FG 624/C...	6,7,8,9,10,11,12,13	06x
FG 624/C...	14,15,16	05x
FG 624/C...	17,18,19,20,21,22	04x
FG 624B/...	PA125, PA250, SN38, ES38	02x
FG 624/CR38		02x
FG 624/...	AD2, AD3	03x

Listino: €

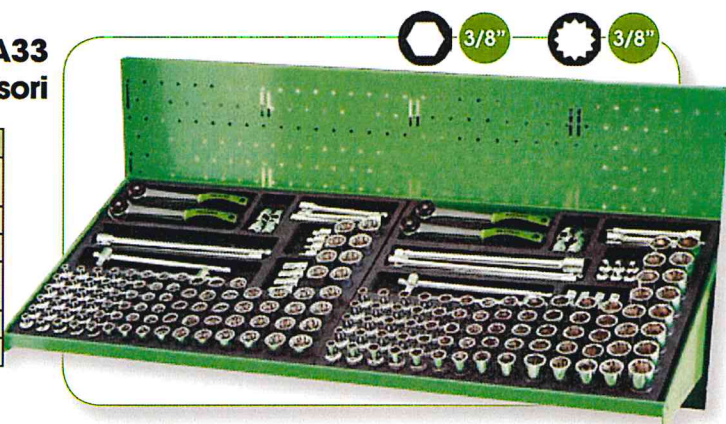

3/8" 3/8"



1/2"

FG 900/A34

Assortimento 146 chiavi a bussola + accessori

CODICE	mm	Q.TÀ
FG 625/A...	23, 24, 25, 26, 30, 32	05x
FG 625/A...	21, 22, 27	06x
FG 625/A...	15, 16, 17, 18, 19, 20	07x
FG 625/A...	10, 11, 12, 13, 14	08x
FG 625/A...	PA 75, PA 125, PA 250, ES12, AD2, AD3	02x
FG 625/SN12		03x
		04x

€

FG 900/A35

Assortimento 148 chiavi a bussola + accessori

CODICE	mm	Q.TÀ
FG 625/C...	9, 20, 21, 23, 24	03x
FG 625/C...	8, 12, 30, 32	04x
FG 625/C...	22, 25, 26, 27	06x
FG 625/C...	17, 18, 19	07x
FG 625/C...	10, 13, 14, 15, 16	08x
FG 625/...	PA75, PA125, PA250, ES12, AD2 AD3, CR12 (04pz)	02x
FG 625/SN12		

Listino: €



1/2"

3/4"



FG 900/A37

Assortimento 63 chiavi a bussola + accessori

CODICE	mm	Q.TÀ
FG 629/A...	46, 50, 55, 60	01x
FG 629/A...	41	02x
FG 629/A...	27, 29, 30, 32, 33, 34, 35, 36, 38	03x
FG 629/A...	19, 22, 23, 26, 28	04x
FG 629/...	PR200, PR400, SN34, ES34, CR14	02x

Listino: €

FG 900/A38

Assortimento 59 chiavi a bussola + accessori

CODICE	mm	Q.TÀ
FG 629/B...	46, 50, 55, 60	01x
FG 629/B...	41	02x
FG 629/B...	27, 29, 30, 32, 33, 34, 35, 36, 38	03x
FG 629/B...	19, 22, 23, 26, 28	04x
FG 629/...	PR200, PR400, SN34, ES34, CR14	02x

Listino: €



FG 900/A50

Assortimento mazette e martelli in gomma

CODICE	mm	Q.TÀ
FG 134/H...	800, 1.000, 1.250, 1.500, 2.000	03x
FG 135/...	35, 40, 50, 60	03x

Listino: €

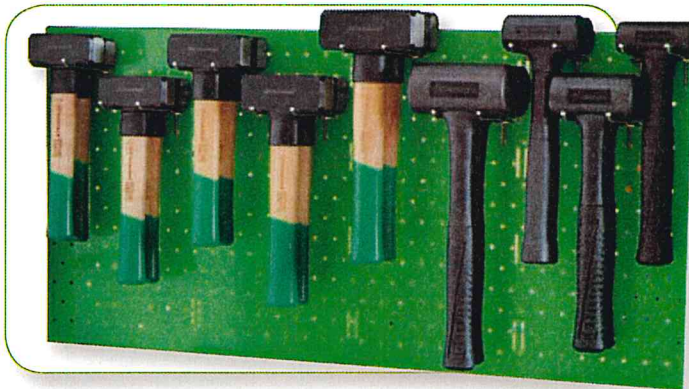

FG 900/A51

Assortimento martelli e mazzuole

CODICE	mm	Q.TÀ
FG 132/H...	200, 300, 500, 800, 1.000, 1.500	04x
FG 136/...	30, 40, 50	04x

Listino: €



**FG 900/A52****Assortimento utensili da percussione**

CODICE	mm	C.AD
FG 128/P...	1, 2, 3, 4, 5, 6	05x
FG 128/C...	2, 3, 4, 5, 6, 8	05x
FG 128/U5		05x
FG 127/P1		05x
FG 127/BE...	3, 4, 5	05x
FG 126/SN...	1, 2, 3, 4, 5	05x
FG 132/...	500	08x

Listino: €

FG 900/A53
Assortimento utensili manutenzione generale

CODICE	mm	C.AD
FG 79/SP3		03x
FG 79/SP2		02x
FG 80/8A...	R, M, P, T, Q	03x
FG 83/S6		05x
FG 47/P...		

Listino: €

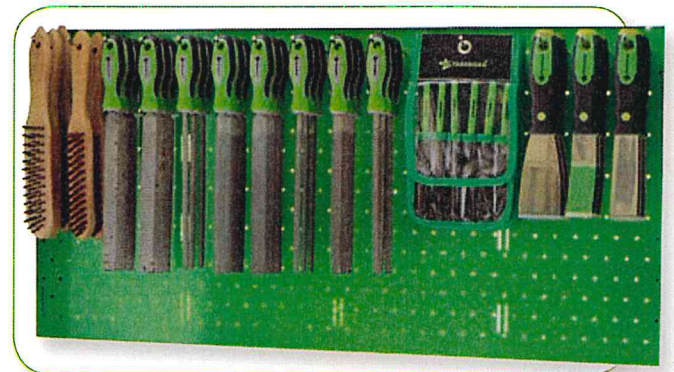
**FG 900/A54****Assortimento 27 pinze autobloccanti**

CODICE	mm	C.AD
FG 69/CJ...	180, 250	03x
FG 69/PP215		03x
FG 69/CP...	170, 280	03x
FG 69/CC...	170, 280	03x
FG 69/LN...	170, 230	03x

Listino: €



FG 900/A60
Assortimento 29 utensili da taglio

CODICE	mm	C.AD
FG 49/HE...	200, 250, 300, 350	04x
FG 49/...	CS, CL, CR	05x
FG 69/PC		02x

Listino: €





FG 900/A61
Assortimento 50 utensili da taglio

CODICE	mm	Q.TÀ
FG 50/...	MA, MN	05x
FG 50/MS		10x
FG 77/TT		10x
FG 48/FK		10x
FG 50/MI		10x

Listino: €

FG 900/A62
Assortimento 65 utensili da taglio

CODICE	mm	Q.TÀ
FG 48/L		10x
FG 48/KL10		10x
FG 48		10x
FG 49		20x
FG 49/MU		05x
FG 49/L		05x
FG 76/R...		

Listino: €



FG 900/A63
Assortimento 70 utensili da taglio

CODICE	mm	Q.tà
FG 48/L		10x
FG 48/B		05x
FG 48/K...	K10, K12	10x
FG 48/P		10x
FG 48/FK		10x
FG 49		10x
FG 49/MU		10x
		05x

Listino: €



FG 900/A80
Assortimento 11 utensili ad aria compressa

CODICE	Attacco	Q.TÀ
FGA 304	3/8"	01x
FGA 307	1/2"	01x
FGA 308	1/2"	01x
FGA 309	1/2"	01x
FGA 310	3/4"	01x
FGA 333, FGA 332/AN, FGA 338, FGA338/L, FGA 338/AN, FGA 330		01x

Listino: €

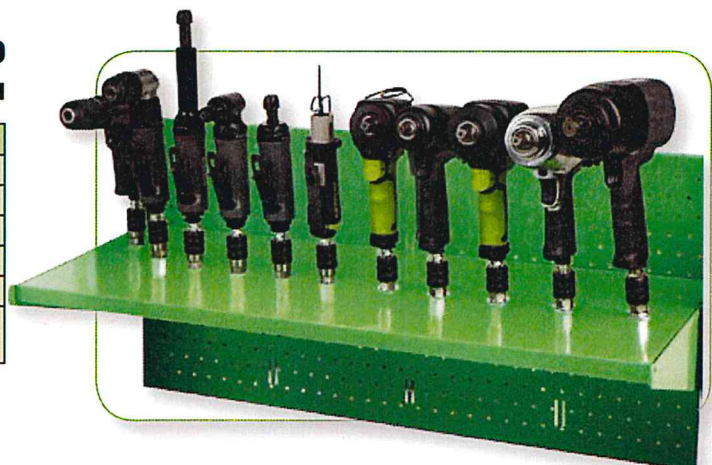



FG 900/A81

Assortimento 19 avvitatori ad aria compressa

CODICE	Attacco	Q.TÀ
FGA 304	3/8"	02x
FGA 307	1/2"	02x
FGA 308	1/2"	02x
FGA 309	1/2"	02x
FGA 310	3/4"	01x

Listino: €

FG 900/A82

Assortimento 5 utensili ad aria compressa + bussole e accessori rinforzati

CODICE	mm	Q.TÀ	CODICE	Attacco	Q.TÀ
FG 628/C...	10, 11, 12, 13, 14, 15, 16, 17, 18, 19, 21, 22, 23, 24, 27, 30, 32	02x	FGA 304	3/8"	01x
FG 628/PR...	125, 250, 380	02x	FGA 307	1/2"	01x
FG 628/AD...	1, 2, 3	02x	FGA 308	1/2"	01x
FG 629/AD...	1, 2	02x	FGA 309	1/2"	01x
FG 629/SN34R		02x	FGA 310	3/4"	01x

Listino: €



FG 900/A85B

Assortimento 27 utensili per filtri olio

CODICE	mm	Q.TÀ
FG 176/FO...	1, 2	03x
FG 177/FO1		02x
FG 176/NA...	1, 2	04x
FG 176/RE		05x
FG 176/CJ		05x
FG 178/SD		01x

Listino: €



FG 900/A86

Assortimento 30 utensili Automotive

CODICE	mm	Q.TÀ
FG 175/FO14T		05x
FG 175/FO1		03x
FG 175/FO14M		05x
FG 178/SD		02x
FG 175/XZN16		05x
FG 173/SC...	1, 2	03x
FG 196/A12		

Listino: €



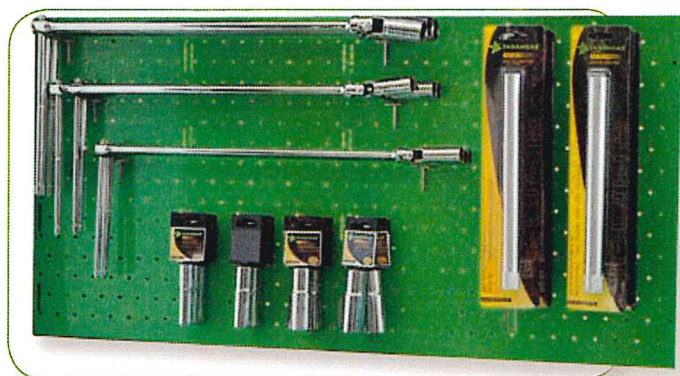

FG 900/A87
Assortimento 41 utensili Automotive

CODICE	mm	Q.TÀ
FG 181T/A...	14, 16, 21	03x
FG 181/B...	14, 16, 18, 21	03x
		10x

Listino: €

FG 900/A88B
Assortimento pinze speciali Automotive

CODICE	Q.TÀ
FG 172/AS	03x
FG 172/FA	05x
FG 172/CL	05x
FG 172/MJ	05x
FG 172/GO	03x
FG 172/CA	

Listino: €



FG 900/A89B
Assortimento set specifici per rimozione candele

CODICE	Q.TÀ
FG 182/S16	02x
FG 183/S5	05x
	02x

Listino: €

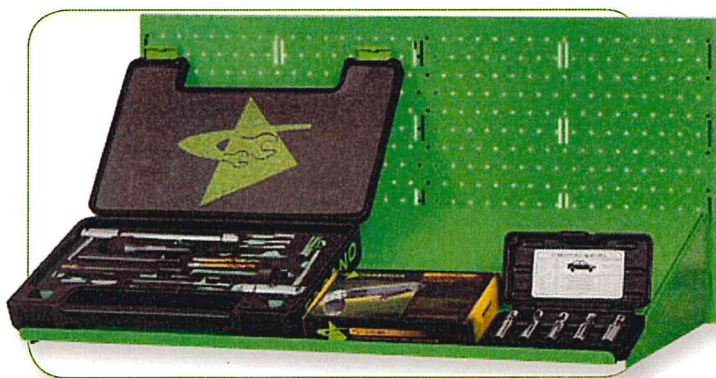

FG 900/A89
Assortimento set specifici per elettro-iniettori

CODICE	Q.TÀ
FG 190/ES	02x
FG 190/S5	01x
FG 190/S6B	

Listino: €



**FG 900/A89C**

Assortimento 4 set specifici Automotive

CODICE	Q.tà
FG 202/PV	02x
FG 201/CR	02x

Listino: €

FG 900/A89E
 Assortimento utensili per gommisti

CODICE	mm	Q.TÀ
FG 198/A2	17x19x21x1/2"	06x
FG 164		06x
FG 126/A500	500mm	06x
FG 126/A400	400mm	05x
FG 169/...	BS, BS1	01x
FG 65SR/250		

Listino: €

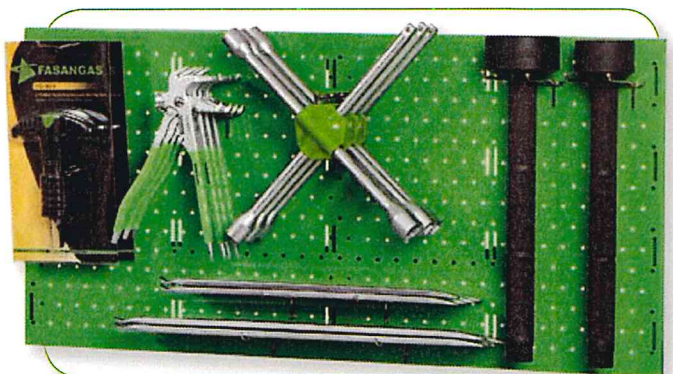
**FG 900/A89D**

Assortimento utensili per gommisti

CODICE	mm	Q.TÀ
FG 199/PF		03x
FG 199/PF1		01x
FG 199/A		03x
FG 199/PM1		03x
FG 628/S3	17,19,21mm	05x
FG 628L/S3	17,19,21mm	02x
		01x

Listino: €

FG 900/A89G
 Assortimento utensili speciali per carrozzeria

CODICE	mm	Q.TÀ
FG 130/....	TP, TQ, TZQ, TPP	02x
FG 131/PL		02x
FG 131/PL9R		02x
FG 131/PL12R		02x
FG 186P/S5		05x
FG 131/SC		

Listino: €

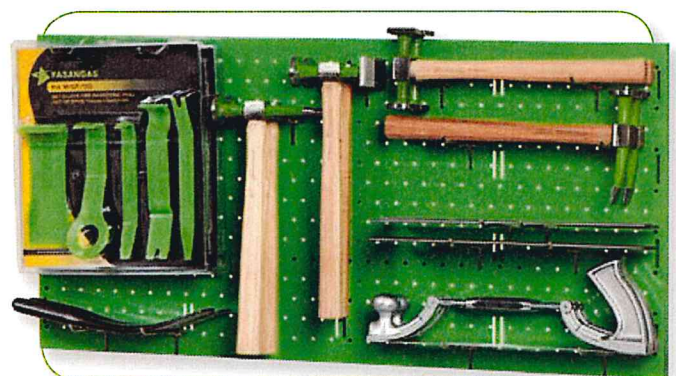

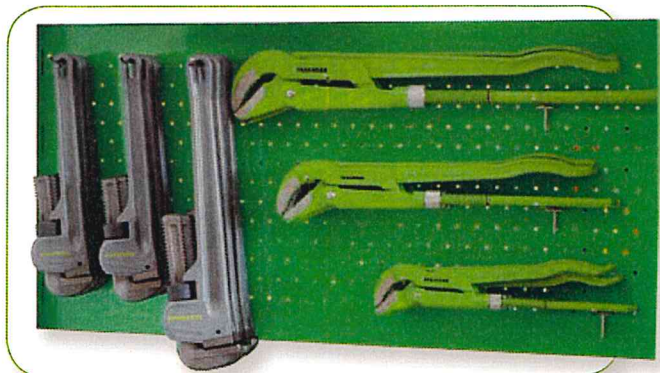

FG 900/A91
Assortimento 24 giratubo

CODICE	mm	Q.tà
FG 33/GA...	2, 2,5, 3	04x
FG 32/GP...	1, 1,5, 2	04x

Listino: €

FG 900/A92
Assortimento 24 giratubo

CODICE	mm	Q.TÀ
FG 31/GP...	1, 1,5, 2	04x
FG 32/GS...	1, 1,5, 2	04x

Listino: €

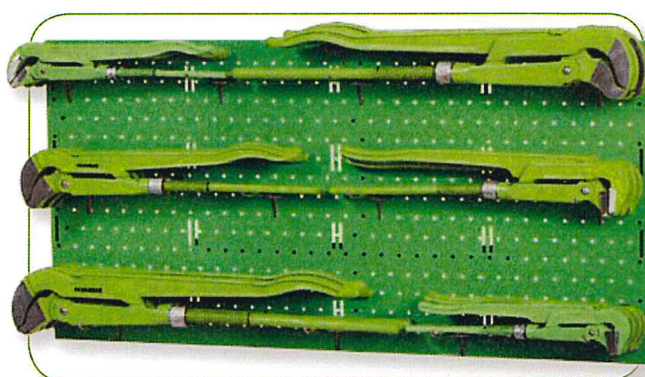

FG 900/A93
Assortimento 24 utensili per idraulica

CODICE		Q.TÀ
FG 21/CD		02x
FG 21/CR		03x
FG 79/SB		02x
FG 79/SR		03x
FG 76/R...	1, 2, 3	02x
FG 77/PVC3		02x
FG 34/GL...	1, 1,5	02x
FG 24/CU...	1, 2	01x

Listino: €



FG 900/A90
Assortimento 24 utensili per idraulica

CODICE	mm	Q.TÀ
FG 20/A2		05x
FG 21/CR		05x
FG 21/CS		03x
FG 21/CD		02x
FG 24/CU1		02x
FG 79/SR		05x
FG 79/SB		

Listino: €





FG 910/M1
Espositore da parete giraviti ESTRO per viti con testa ad intaglio

CODICE	mm	Q.TÀ
FG 22/...	12x250	02x
FG 22/...	4x30,6.5x30,10x200	03x
FG 22/...	8x150	05x
FG 22/...	5.5x100,5.5x150,6.5x150	06x
FG 22/...	2.5x60,3x75,3x100,3.5x100,4x100,4x125	07x



Listino: €

FG 910/M2
Espositore da parete giraviti ESTRO per viti a croce PH

CODICE	mm	Q.TÀ
FG 22/...	PH4x200	05x
FG 22/...	PH3x150	05x
FG 22/...	PH2x100H	05x
FG 22/...	PH1x30,2x30,1x80,1x200,2x100,2x150	06x
FG 22/...	PH0x60	07x



Listino: €



FG 910/M3
Espositore da parete giraviti ESTRO per viti con testa ad intaglio e a croce PH

CODE	mm	Q.TÀ
FG 22/...	8x150	02x
FG 22/...	4x30, 4x125, 6.5x30, 5.5x100,5.5x150,10x200 PH1x30,PH2x30, PH1x80, PH2x100	03x
FG 22/...	4x100	04x
FG 22/...	PH3x150	05x
FG 22/...	6.5x150	06x
FG 22/...	3x75, 3.5x100	07x



Listino: €



FG 910/M4
Espositore da parete giraviti ESTRO per viti impronta Torx e Torx forata

CODICE	mm	Q.TÀ
FG 22/...	TX6, TX7, TX27, TX30, RTX10, RTX15, RTX20, RTX25, RTX27	03x
FG 22/...	RTX9	03x
FG 22/...	TX10, TX15, TX20, TX25,	06x
FG 22/...	TX8, TX9	07x



Listino: €





FG 910/M5
Espositore da parete giraviti ESTRO
a bussola ad asta flessibile e rigida

CODICE	mm	Q.TÀ	CODICE	mm	Q.TÀ
FG 22/FL...	10x125	02x	FG 22/FX...	10x125	02x
FG 22/FL...	8x125	03x	FG 22/FX...	8x125	03x
FG 22/FL...	5x125,6x125, 7x125	05x	FG 22/FX...	5x125,6x125, 7x125	05x

Listino: €

FG 910/M6
Espositore da parete giraviti ESTRO
con testa esagonale sferica



CODICE	mm	Q.TÀ
FG 22/H...	2, 2,5, 3, 4, 5, 6, 8	03x

Listino: €



FG 910/M7
Espositore da parete giraviti ESTRO ISOLATI
per viti con testa ad intaglio e a croce PH

CODE	mm	Q.TÀ
FG 22E/...	6,5x150, 8x175 PH1x80, PH2x100, PH3x150 PZ1x80, PZ2x100, PX3x150	03X
FG 22E/...	PH0x60 PZ0x60	04X
		07x



Listino: €



FG 910/M9
Espositore da parete pinze assortite

CODICE	mm	Q.tà
FG 59SR/...	160, 180	02x
FG 59SR/...	200	01x
FG 60SR/...	160	03x
FG 62SR/...	160	02x
FG 63SR/...	160	05x
FG 63SR/H...	180	02x
FG 63SR/H...	200	03x
FG 61SR/...		

Euro: €

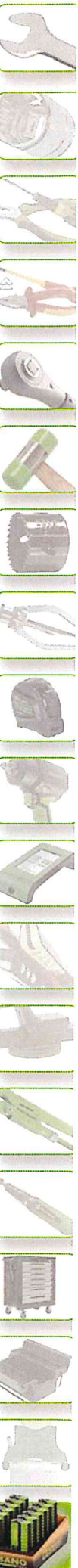
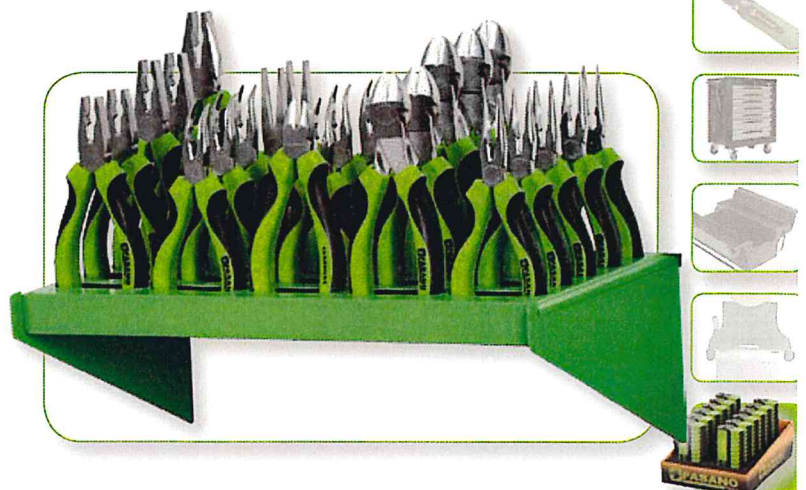

FG 910/M10

Espositore da parete pinze assortite

CODE	mm	Q.tà
FG 59SR/...	180	02x
FG 59SR/...	200	03x
FG 61SR/...	160	02x
FG 60SR/...	160	03x
FG 63SR/...	160	02X
FG 63SR/H...	180	03X
FG 58B/...	180	02x
FG 58B/...	240	05x
FG 58B/...	300	03x

Listino: €



FG 910/M11

Espositore da parete pinze per anelli elastici assortite

CODE	mm	Q.tà
FG 51/, FG 52/, FG 53/, FG 54/	140	02x
FG 51/, FG 52/, FG 53/, FG 54/	180	03x
FG 51/, FG 52/, FG 53/, FG 54/	230	01x

Listino: €

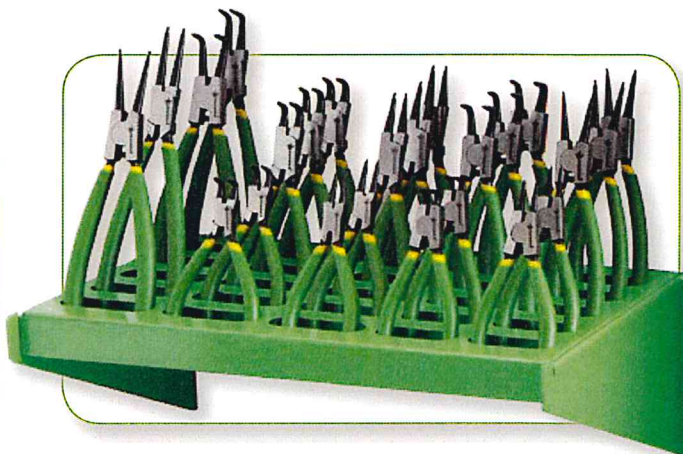

FG 910/M20

Espositore da parete chiavi maschio esagonali con impugnatura

CODE	mm	Q.tà
FG 142/...	2.5	05x
FG 142/...	2, 3, 4, 5, 6, 8, 10	04x

Listino: €



FG 910/M21

Espositore da parete chiavi maschio Torx con impugnatura

CODE	mm	Q.tà
FG 143/TX...	15	05x
FG 143/TX...	10, 20, 25, 40, 45, 50	04x
		02X

Listino: €

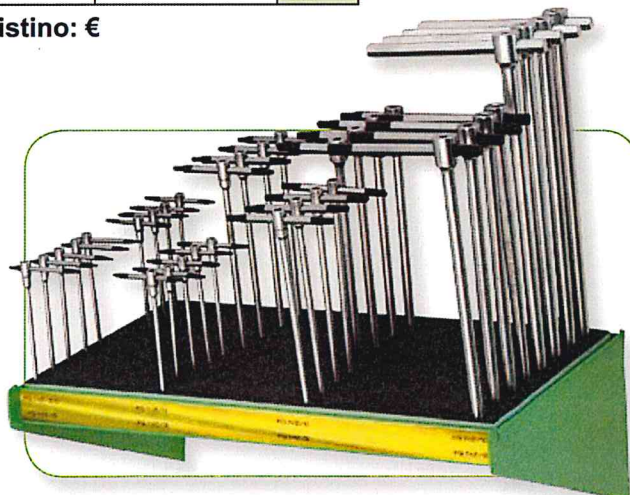

FG 910/M22

Espositore da parete chiavi maschio esagonali



CODE	mm	Q.tà
FG 621/H...	2.5	05x
FG 621/H...	2, 3, 4, 5, 6, 8, 10	04x

Listino: €

FG 910/M23

Espositore da parete chiavi maschio Torx



CODE	mm	Q.tà
FG 621/TX...	15	05x
FG 621/TX...	10, 20, 25, 40, 45, 50	04x
FG 621/TX...	27, 30	02X

Listino: €



FG 910/M30
Espositore da parete utensili a percussione

CODE	mm	Q.tà
FG 128/P..	1, 2, 3, 4, 5, 6	05x
FG 128/C...	2, 3, 4, 5, 6, 8	05x
FG 128/U5		05x
FG 127/P1		05x
FG 127/BE...	3, 4, 5	05x
FG 126/SN...	1, 2, 3, 4, 5	05x

Listino: €

FG 910/M16
Espositore da parete inserti a bussola Torx corti e lunghi

NEW

CODE	Q.tà
FG 150/TX10 - FG 150/TX30	05x
FG 150L/TX30-FG 150L/TX50	05x

Listino: €

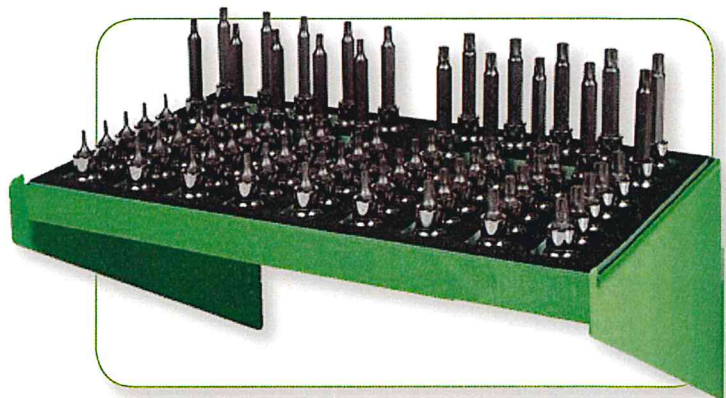

FG 910/M17
Espositore da parete inserti a bussola XZN corti e lunghi

CODE	Q.tà
FG 150/M5-FG 150/M14	05x
FG 150/M16	04x
	05x

Listino: €

NEW



FG 910/M18
Espositore da parete inserti a bussola esagonali corti e lunghi

NEW

CODE	Q.tà
FG 150/H2-FG 150/H10	05x
FG 150L/H2-FG 150L/H10	05x

Listino: €

